

# HAKKO FX-888

SOLDERING STATION

## Instruction Manual

Thank you for purchasing HAKKO FX-888 soldering station.  
Please read this manual before operating the HAKKO FX-888.  
Keep this manual readily accessible for reference.

### 1. PACKING LIST AND PART NAMES Please check to make sure that all items listed below are included in the package.

HAKKO FX-888 Station	1	Hexagon wrench	1
HAKKO FX-8801	1	CAL adjustment driver*	1
Iron holder	1		
Instruction Manual	1		

\*CAL adjustment driver is attached to the bottom of the station.

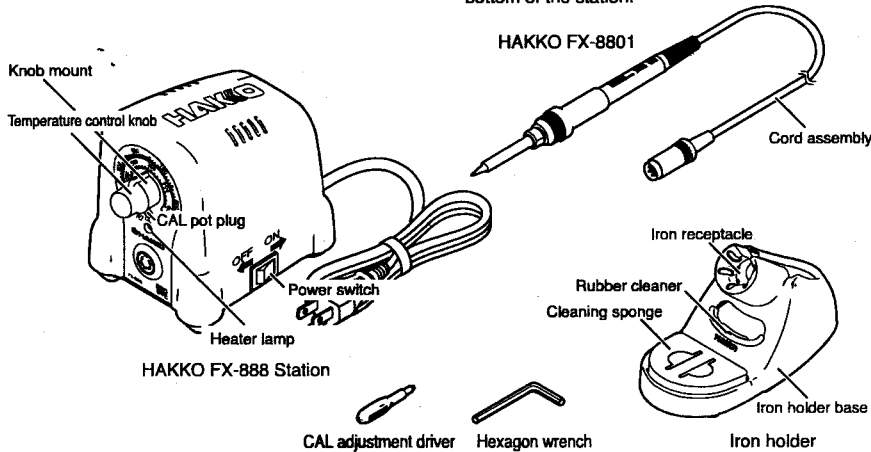

### 2. SPECIFICATIONS

Power consumption	70W
<b>● Station</b>	
Output	AC26V
Temperature Range	200~450°C
Temperature Stability	±1°C at idle temperature
Dimensions (W x H x D)	100(W) x 120(H) x 130(D)mm
Weight(w/o cord)	1.3kg

#### ● HAKKO FX-8801 Soldering iron

Power Consumption	AC26V 65W
Tip to Ground Resistance	<2Ω
Tip to Ground Potential	<2mV
Heating Element	Ceramic heater
Cord	1.2m
Total Length (w/o cord)	190mm
Weight (w/o cord)	44g

- \* The temperature was measured using the FG-100 thermometer.
- \* This product is protected against electrostatic discharge.
- \* Specifications and design are subject to change without notice.

#### ⚠ CAUTION

This product includes such features as electrically conductive plastic parts and grounding of the handpiece and station as measures to protect the device to be soldered from the effects of static electricity. Be sure to observe the following instructions:

1. The handle and other plastic parts are not insulators, they are conductors. When replacing parts or repairing, take sufficient care not to expose live electrical parts or damage insulation materials.
2. Be sure to ground the unit during use.

#### 中國RoHS: 產品中有毒有害物質或元素的名稱及含量

部件名稱	有毒有害物質或元素					
	鉛(Pb)	汞(Hg)	鎘(Cd)	六價鉻(Cr(VI))	多溴聯苯(PBB)	多溴二苯醚(PBDE)
焊鐵部	×	○	○	○	○	○
插頭	×	○	○	○	○	○

○ : 表示該有毒有害物質在該部件所有均質材料中的含量均在SJ/T 11363-2006標準規定的限量要求以下。  
 × : 表示該有毒有害物質至少在該部件的某一均質材料中的含量超出SJ/T 11363-2006標準規定的限量要求。

註有「附帶 BS 插頭」之時，表示「插頭」為含有有害物質的部件。

### 3. WARNINGS, CAUTIONS, NOTES AND EXAMPLES

#### **⚠ WARNING**

Warnings, cautions and notes are placed at critical points in this manual to direct the operator's attention to significant items. They are defined as follows:

- ⚠ WARNING:** Failure to comply with a WARNING may result in serious injury or death.
- ⚠ CAUTION :** Failure to comply with a CAUTION may result in injury to the operator, or damage to the items involved. Two examples are given below.

#### **⚠ CAUTION**

When power is ON, tip temperatures will be between 200 and 450°C. (392 to 840°F.) To avoid injury or damage to personnel and items in the work area, observe the following:

- Do not touch the tip or the metal parts near the tip.
- Do not allow the tip to come close to, or touch, flammable materials.
- Inform others in the area that the unit is hot and should not be touched.
- Turn the power off when not in use, or left unattended.
- Turn the power off when changing parts or storing the HAKKO FX-888.
- This appliance is not intended for use by persons (including children) with reduced physical, sensory or mental capabilities, or lack of experience and knowledge, unless they have been given supervision or instruction concerning use of the appliance by a person responsible for their safety.
- Children should be supervised to ensure that they do not play with the appliance.
- If the power cord is damaged, it must be replaced by the manufacturer, its service agent or similarly qualified person in order to avoid personal injury or damage to the unit.

To prevent accidents or damage to the HAKKO FX-952, be sure to observe the following:

- Do not use the HAKKO FX-888 for applications other than soldering.
- Do not strike the iron against hard objects to remove excess solder. This will damage the iron.
- Do not modify the HAKKO FX-888.
- Use only genuine Hakko replacement parts.
- Do not allow the HAKKO FX-888 to become wet, or use it with wet hands.
- Remove power and iron cords by holding the plug, not the wires.
- Be sure the work area is well ventilated. Soldering produces smoke.
- While using HAKKO FX-888, don't do anything which may cause bodily harm or physical damage.

### 4. OPERATION

#### A. Iron Holder

- The sponge is compressed. It will swell when moistened with water. Before using the unit, dampen the sponge with the water.
1. Fit the small sponge in any of the holes of the iron holder base.
  2. Add an appropriate amount of water into the iron holder base. The small sponge will absorb water to keep the wet state at all times.
  3. Dampen the large sponge and place it on the iron holder base.
- \* When Using a Cleaning Wire  
See "3. Using a Cleaning Wire" in "5. MAINTENANCE."

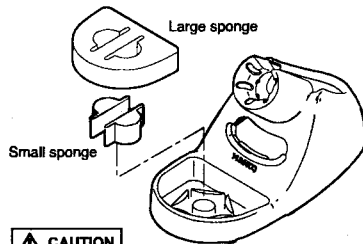

#### **⚠ CAUTION**

Be sure the sponge is moistened with water before use to avoid damaging the tip.

#### B. Connections

#### **⚠ CAUTION**

Be sure to turn off the power before connecting or disconnecting the cord assembly for the iron to and from the receptacle to avoid damaging the circuit board.

1. Connect the cord assembly to the receptacle.

#### **⚠ CAUTION**

- Do not use an iron other than the HAKKO FX-8801. Doing so may not result in the performance indicated in the specifications.
- Do not plug FT-8001 handpiece. This will damage the circuit board.

2. Place the iron part in the iron holder.
3. Plug the power cord into the power supply.

#### **⚠ CAUTION**

This unit is protected against electrostatic discharge and must be grounded for full efficiency.

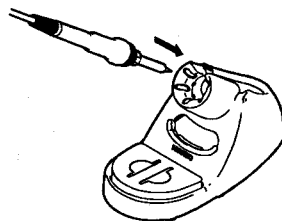
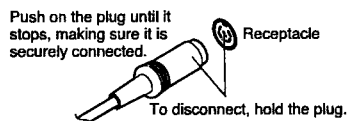

#### C. Temperature Setting

1. Set the temperature control knob to the desired temperature.
2. Lock the knob.

The HAKKO FX-888 station is equipped with a temperature control knob lock. (See the drawing on the right.)

After setting the desired temperature, tighten the hexagon socket head cap screw on the underside of the knob mount using the supplied hexagon wrench. Turn the nut clockwise to tighten the knob lock.

#### **⚠ CAUTION**

- Don't overtighten the hexagon socket head cap screw.
- Don't attempt to turn the knob when the knob lock is on.

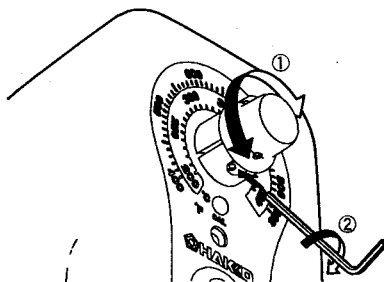

## 4. OPERATION

### D. Turn on the Power Switch

The heater lamp blinks on and off when the tip temperature reaches the set temperature. The unit is now ready to perform soldering work.

#### CAUTION

- The iron part must be placed in the iron holder when not in use.
- Turn the power off when not using the units for a long time.

### E. After Use

When done, wipe the tip clean and coat the tip with fresh solder.

## 5. MAINTENANCE

Performing proper and periodical maintenance extends the products life and contributes to use it always in a good condition. Efficient soldering depends upon the temperature, the quality and quantity of the solder and flux. Apply the following service procedure as dictated by the conditions of the usage.

#### WARNING

Since the soldering iron can reach a very high temperature, please work carefully. Except the case especially indicated, always turn the power switch OFF and disconnect the power plug before performing any maintenance procedure.

### Tip Maintenance

1. Set the temperature to 250°C (482°F).
2. When the temperature stabilizes, clean the tip with the cleaning sponge and check the condition of the tip.
3. If the solder plated part of the tip is covered with black oxide, apply fresh solder, containing flux, and clean the tip again. Repeat until all the oxide is removed, then coat the tip with fresh solder.
4. If the tip is deformed or heavily eroded, replace it with a new one.

#### CAUTION

Do not file the tip in an attempt to remove the black oxide.

Use the cleaning sponge that comes in the product set to clean the tip.

It offers wide-ranging uses, from simple removal of excess solder to complete elimination of matter occurring as a result of oxidization.

### Cleaning the tip using the iron holder

#### 1. Using the cleaning sponge

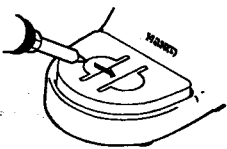

#### 2. Using the rubber cleaner

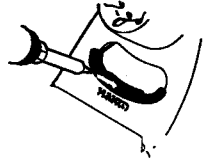

#### 3. Using a cleaning wire

If a cleaning wire (option) is used, place it in the bottom plate as shown on the right.



Alternatively, you can use the rubber cleaner to clean the tip as shown on the left. It is a handy way of casually removing excess solder.

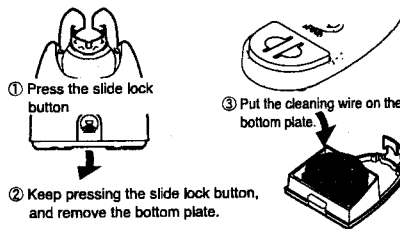

Foreign matter resisting removal with the mouth cap or cleaning sponge may more easily be removed with a cleaning wire.

#### NOTE

If solder debris builds up in the bottom plate, remove the bottom plate in the same way.

### Calibration of the Tip Temperature

The tip temperature should be recalibrated after changing the iron part, or replacing the heating element or tip.

1. Connect the cord assembly plug on the iron side to the receptacle on the station.
2. Set the temperature control knob to 350°C (662°F).
3. Turn the power switch to "ON" and wait until the temperature stabilizes. Detach the CAL pot plug.
4. When the iron tip temperature stabilizes, measure the tip temperature using an tip thermometer. As necessary, fit the included CAL adjustment driver in the hole in the station indicated by the CAL marking, and make adjustments so that the tip temperature is 350°C (662°F).

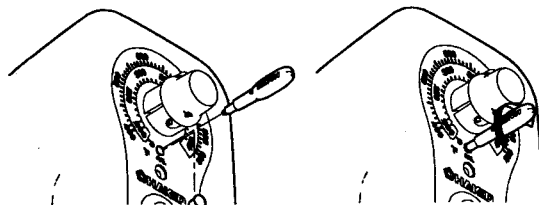
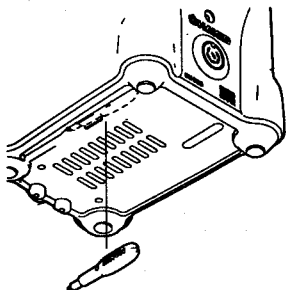

## 5. MAINTENANCE

Disconnect the plug of the cord assembly and measure the resistance value between the connecting plug pins of the iron part as follows.

If the values of "a" and "b" are outside the value in the table, replace the heating element (sensor) and/or cord assembly.

If the value of "c" is over the value in the table, remove the oxidization film by lightly rubbing with sand-paper or steel wool the points shown in the drawing on the right.

a. Between pins 4 & 5 (Heating Element)	2.5 - 3.5 $\Omega$ (at time of room temperature)
b. Between pins 1 & 2 (sensor)	43 - 58 $\Omega$
c. Between pin 3 & Tip	2 $\Omega$ or less

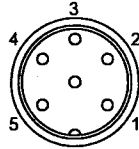

Buff lightly.



● Disassembling

### 1. Broken Heating Element/Sensor

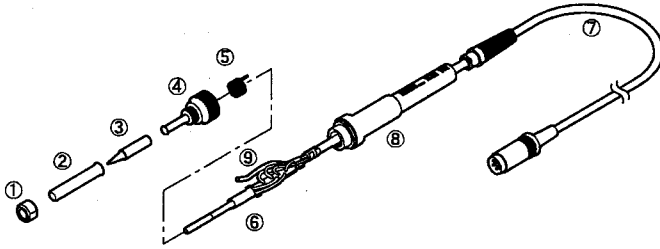

Heating element resistance (red)  
Sensor resistance (blue)



1. Turn the nut ① counterclockwise and remove the tip enclosure ② and the tip ③.
2. Turn the nipple ④ counterclockwise and remove it from the iron.
3. Pull both the heating element ⑥ and the cord assembly ⑦ out of the handle ⑧. (Toward the tip of the iron).
4. Pull the grounding spring ⑤ out of the sleeve of the terminal ⑨.

\* Measure when the heating element is at room temperature.

1. Heating element resistance (red) 2.5 - 3.5  $\Omega$
2. Sensor resistance (blue) 43 - 58  $\Omega$

If the resistance value is not normal, replace the heating element. (Refer to the instructions included with the replacement part.)

After replacement

- ① Measure the resistance between 1) pins 4 and 1 or 2; 2) pins 5 and 1 or 2. If it is not  $\infty$ , the heating element and sensor are touching. This will damage the circuit board.
- ② Measure the resistance "a," "b," and "c" to confirm that the leads are not twisted and that the grounding spring is properly connected.

1. Turn the unit ON and set the temperature control knob to 450°C (842°F). Then wiggle and kink the iron cord at various locations along its length, including in the strain relief area. If the LED heater lamp flashes, then the cord needs to be replaced.

### CAUTION

The power lamp starts to flash when the temperature reaches 450°C (842°F) regardless of the condition of the cord.

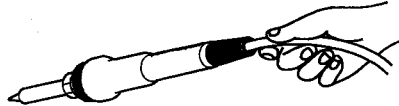

2. Check the resistance between the plug pin and the terminal lead.

Pin 1: Red Pin 2: Blue Pin 3: Green Pin 4: White Pin 5: Black

Resistance: 0  $\Omega$ .  
If it is higher than 0  $\Omega$  or is  $\infty$ , the cord should be replaced.

### 2. Broken Cord Assembly

There are two methods of testing the cord assembly.

### 3. Fuse Replacement

The fuse must be replaced together with the "printed board/for fuse." (See the drawing in "7. PARTS LIST.")

## 6. TROUBLE SHOOTING GUIDE

### ⚠ WARNING

• Before checking the inside of the FX-888 or replacing parts, be sure to disconnect the power plug.  
 • If the power cord is damaged, it must be replaced by the manufacturer, its service agent or similarly qualified person in order to avoid personal injury or damage to the unit.

- Nothing happens when the power switch is turned on.

**CHECK:** Is the power cord and/or connecting plug disconnected?  
**ACTION:** Connect it.

**CHECK:** Is the fuse blown?

**ACTION:** Determine why the fuse blew and eliminate the cause, then replace the fuse.

a. Is the inside of the iron part short-circuited?

b. Is the grounding spring touching the heating element?

c. Is the heating element lead twisted and short-circuited?

Try replacing the fuse even if the cause cannot be identified. If it still blows, return the product for repair.

- The heater lamp lights up but the tip does not heat up.

**CHECK:** Is the cord assembly broken? Is the heating element/sensor broken?

**ACTION:** Refer to "Broken Cord Assembly" and "Broken Heating Element/Sensor."

- The tip heats up intermittently.

**CHECK:** Is the cord assembly broken?

**ACTION:** Refer to "Broken Cord Assembly."

- The tip is not wet.

**CHECK:** Is the tip temperature too high?

**ACTION:** Set an appropriate temperature.

**CHECK:** Is the tip coated with black oxide?

**ACTION:** Remove the black oxide. (Refer to "Tip Maintenance.")

- The tip temperature is too low.

**CHECK:** Is the tip coated with black oxide?

**ACTION:** Remove the black oxide. (Refer to "Tip Maintenance.")

**CHECK:** Is the iron temperature calibrated correctly?

**ACTION:** Recalibrate.

- The tip can not be pulled off.

**CHECK:** Is the tip seized? Is the tip swollen because of deterioration?

**ACTION:** Replace the tip and the heating element.

- The tip doesn't hold the desired temperature.

**CHECK:** Is the iron temperature calibrated correctly?

**ACTION:** Recalibrate.

## 7. PARTS LIST

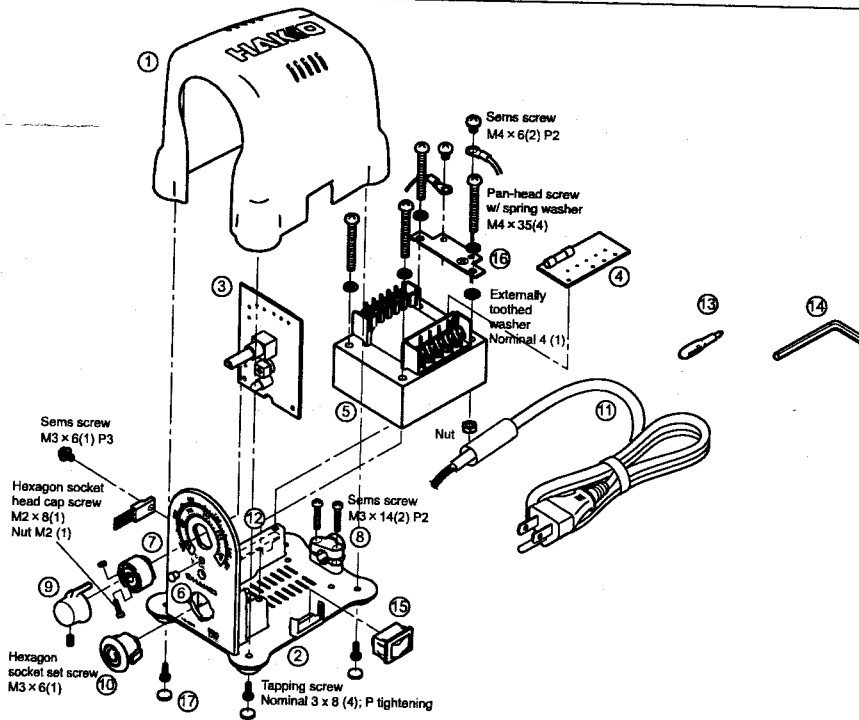

### ● HAKKO FX-888 Station

Item No.	Part No.	Part Name	Specifications
①	B3450	Upper case / BY	
	B3451	Upper case / BK	
	B3452	Upper case / SV	
	B3453	Upper case / RD	
②	B3454	Chassis / Yellow	For BY
	B3455	Chassis / Gray	For BK, SV, RD
③	B3456	P.W.B	For temperature control
④	B3457	P.W.B. / 100-120V	With fuse and rubber feet
	B3490	P.W.B. / 220-240V	With fuse and rubber feet
⑤	B3458	Transformer	100-110V
	B3491	Transformer	220-240V
⑥	B3459	CAL pot plug	
⑦	B3460	Knob mount	
⑧	B3461	Cord stopper	
⑨	B3462	Knob	With hexagon socket set screw

Item No.	Part No.	Part Name	Specifications
⑩	B3463	Receptacle	
⑪	B3492	Power cord, 3 wired cord & American plug	With tube, for USA
	B3493	Power cord, 3 wired cord but no plug	With tube
	B3494	Power cord, 3 wired cord & BS plug	With tube
	B3495	Power cord, 3 wired cord & European plug	With tube, CE
	B3496	Power cord, 3 wired cord & BS plug	With tube, CE
	B3497	Power cord, 3 wired cord & Australian plug	With tube
	B3498	Power cord, 3 wired cord & Chinese plug	With tube
	B3499	Power cord, 3 wired cord & SI plug	With tube
	B3500	Power cord, 3 wired cord & American plug	With tube
	⑫	B3465	Driver support
⑬	B3466	CAL adjustment driver	
⑭	B2017	Hexagon wrench	
⑮	B2852	Switch	
⑯	B2227	Grounding plate	
⑰	B2405	Rubber feet	

## 7. PARTS LIST

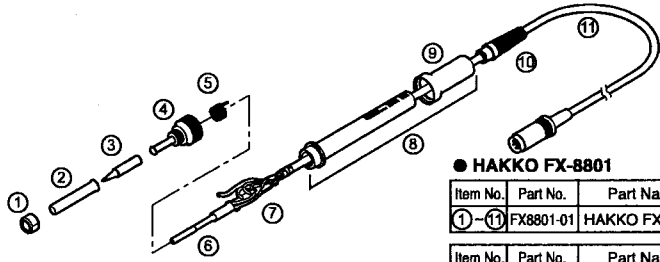

### ● HAKKO FX-8801

Item No.	Part No.	Part Name	Specifications
①-⑪	FX8801-01	HAKKO FX-8801	

Item No.	Part No.	Part Name	Specifications
①	B1785	Nut	
②	B3469	Tip enclosure	
③		Tip	See *8. TIP STYLES*
④	B2022	Nipple	
⑤	B2032	Grounding spring	
⑥	A1560	Heating element	26V-65W
⑦	B2028	Terminal board	With cord stopper
⑧	B3470	Handle	With handle cover
⑨	B3471	Handle cover	
⑩	B3467	Cord bushing	
⑪	B3468	Cord assembly	

### ● HAKKO FH-800

Item No.	Part No.	Part Name	Specifications
①-⑤	FH800-01BY	HAKKO FH-800	Blue-Yellow
①-⑤	FH800-01SV	HAKKO FH-800	Silver

### ● Iron Holder Parts

Item No.	Part No.	Part Name	Specifications
①	A1559	Cleaning sponge	
②	B3472	Iron holder base	Blue-Yellow with rubber feet
	B3473	Iron holder base	Silver with rubber feet
③	B3474	Rubber cleaner	
④	B3475	Bottom plate	With rubber feet
⑤	B3476	Slide lock	

### ● Optional Parts

Item No.	Part No.	Part Name	Specifications
①	A1561	Cleaning wire	

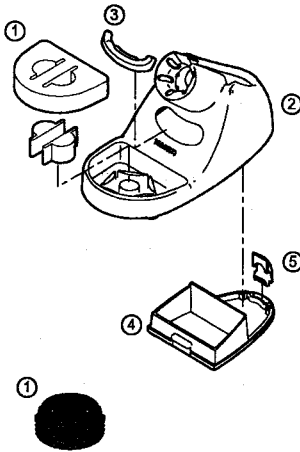

## 8. TIP STYLES

T18-B

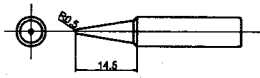

T18-SB

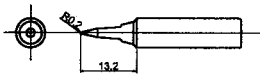

T18-I

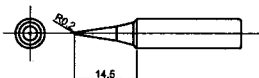

T18-C05

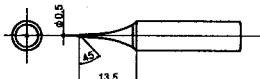

T18-C1  
T18-CF1\*

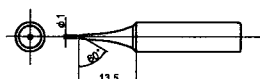

T18-CF15\*

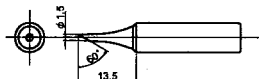

T18-C2  
T18-CF2\*

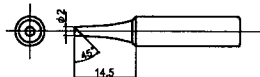

T18-CSF25\*

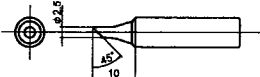

T18-C3  
T18-CF3\*

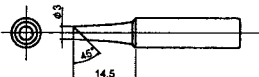

T18-C4  
T18-CF4\*

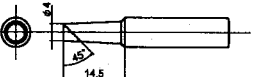

T18-K

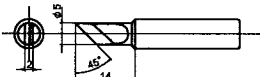

T18-D08

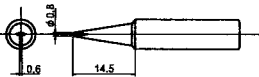

T18-D12

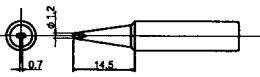

T18-D16

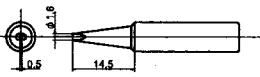

T18-D24

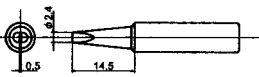

T18-D32

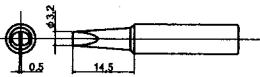

\*Tinned on the soldering surface only.

※Be sure to choose from among these designated tips. Otherwise, the results may not be as indicated in the specifications.

# HAKKO FH-800

IRON HOLDER

FH800-01BY/SV

## INSTRUCTION MANUAL

Thank you for purchasing the iron holder.  
Please read this manual before using the iron holder.

**CAUTION:** The iron holder will become extremely hot.  
Do not touch them.

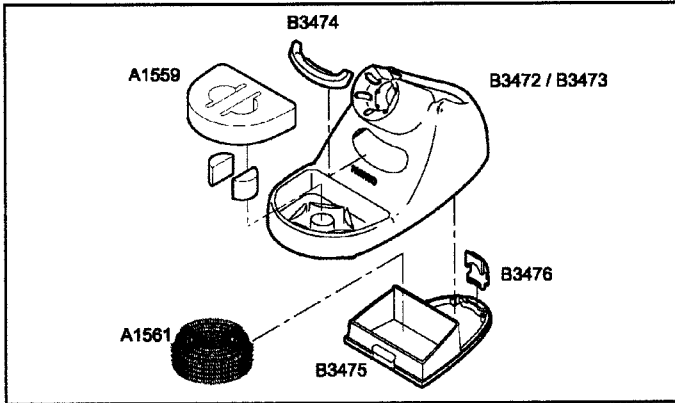

**NOTE:**

The sponge is compressed. It will swell when moistened with water. Before using the unit, dampen the sponge with water and squeeze it dry. Using a dry sponge will damage the soldering tip.

**How to use the cleaning wire:**

- ① Press the slide lock button.
- ② Keep pressing the slide lock button, and remove the bottom plate.
- ③ Put the cleaning wire on the bottom plate.

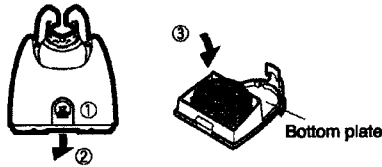

- ④ Insert the bottom plate into the iron holder base.
- ⑤ Remove any residual solder from the tip surface first by thrusting the tip into the cleaning wire.



● Iron Holder Parts

Part No.	Part name	Specifications
A1559	Cleaning sponge	
B3472	Iron holder base/Blue-yellow	BY with rubber foot
B3473	Iron holder base/Silver	SV with rubber foot
B3474	Rubber cleaner	
B3475	Bottom plate	with rubber foot
B3476	Slide lock	
A1561	Cleaning wire	