

# **HAKKO 852**

**SMD REWORK STATION**

SMD Rework Station  
with Vacuum Pickup

## **Instruction Manual**



Thank you for purchasing the Hakko 852 SMD Rework Station. This unit features:

- Digital control and display of time and temperature
- Display of air-flow rate
- Manual and automatic modes
- Built-in vacuum pickup

Please read this manual before operating the Hakko 852. Keep this manual readily accessible for reference.



### **TABLE OF CONTENTS**

PACKING LIST / SPECIFICATIONS .....	1
SAFETY INSTRUCTIONS .....	2
PART NAMES .....	3
PREPARATION: ASSEMBLY AND ELECTRICAL CONNECTION .....	5
OPERATION .....	8
PARAMETERS / INITIAL RESETTING .....	14
MAINTENANCE / INSPECTION .....	15
ERROR MESSAGES / TROUBLESHOOTING .....	16
OPTIONAL PARTS .....	17
PARTS LIST / STATION .....	19
HANDPIECE .....	21
WIRING DIAGRAM .....	22

# PACKING LIST

Check the contents of the Hakko 852 package and confirm that all the items listed below are included.

Hakko 852 station .....	1
Power cord .....	1
Handpiece holder .....	1
Pads ( $\phi$ 5 mm (0.2 in.), $\phi$ 7.6 mm (0.3 in.)) ...	2 each
Instruction manual .....	1

\* This product does not include a nozzle. A large selection of nozzles is available for the Hakko 852. Select the nozzle or nozzles suitable for the work to be performed.

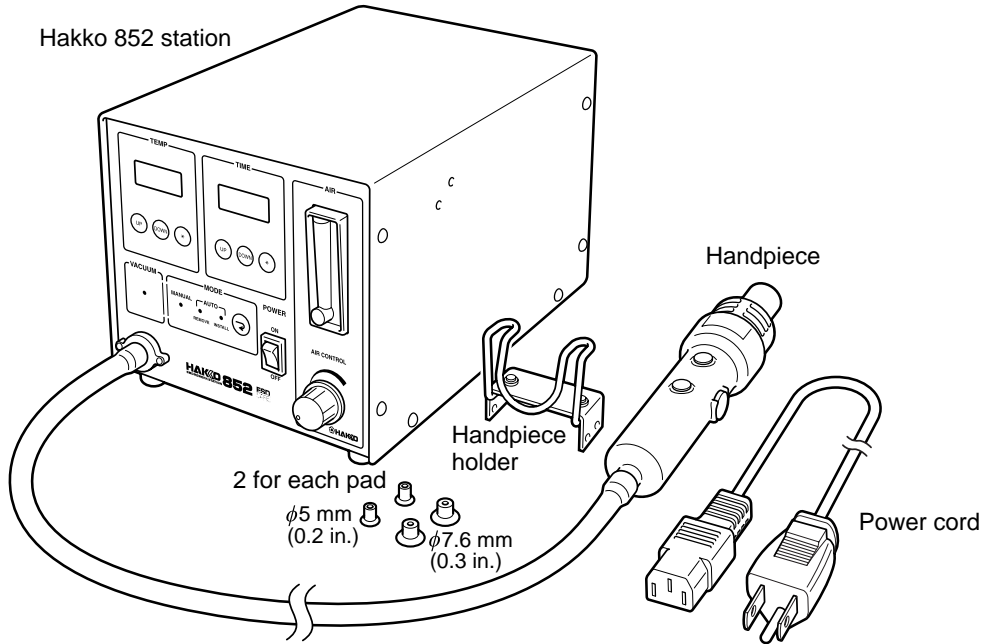

# SPECIFICATIONS

Name	<b>Hakko 852</b>
Power consumption	100V-300W 110V-360W 120V-410W 220V-550W 230V-600W 240V-650W

## ● Station

Power consumption	30 W
Capacity	7 $\ell$ /min to more than 20 $\ell$ /min
Control temperature	100° – 450°C./212° – 842°F. (sensor)
Modes	Manual/Auto
Timer	15 – 999 seconds
External dimensions	260(l) $\times$ 180(w) $\times$ 170(h) mm. 10.2(l) $\times$ 7.1(w) $\times$ 6.7(h) in.
Weight	5 kg. (11.02 lb.)

## ● Handpiece

Power consumption	100V-270W 110V-330W 120V-380W 220V-520W 230V-570W 240V-620W
Total length (w/o cord)	200(l) mm / 7.9(l)in.
Weight (w/o cord)	200 g / 0.44 lb.

\* This product is ESD-protected.

\* Specifications and design subject to change without notice.

# SAFETY INSTRUCTIONS

---

## WARNING

Warnings, cautions are placed at critical points in this manual to direct the operator's attention to significant items. They are defined as follows:

 **WARNING:** Failure to comply with a WARNING may result in serious injury or death.

 **CAUTION:** Failure to comply with a CAUTION may result in injury to the operator, or damage to the items involved. Two examples are given below.

## CAUTION

**When the power is ON, the temperature of the hot air and the nozzle ranges from 100° to 450°C. (212° to 842°F). To avoid injury to personnel or damage to items in the work area, observe the following:**

- Do not direct the hot air toward personnel or touch the metal parts near the nozzle.
- Do not use the product near combustible gases or flammable materials.
- Advise those in the work area that the unit can reach very high temperatures and should be considered potentially dangerous.
- Turn the power OFF when no longer using the Hakko 852 or when leaving it unattended.
- Before replacing parts or storing the unit, allow the unit to cool and then turn the power OFF.

**To prevent accidents and failures, be sure to take the following precautions:**

- Do not strike the handpiece against hard surface or otherwise subject it to physical shock.
- Be sure the unit is grounded. Always connect power to a grounded receptacle.
- Do not disassemble the pump or the vacuum pump.
- Do not modify the unit.
- Use only genuine Hakko replacement parts.
- Do not wet the unit or use the unit with wet hands.
- Remove power cord by holding the plug – not the wires.
- Do not leave the vacuum pump on for long periods of time.
- After using, do not turn the power OFF until “P-S” is displayed on the temperature display.
- Make sure the work area is well ventilated.
- The Hakko 852 is not intended for use by young children or infirm persons without supervision.
- Young children should be supervised to ensure that they do not play with the Hakko 852.

# PART NAMES

## Station

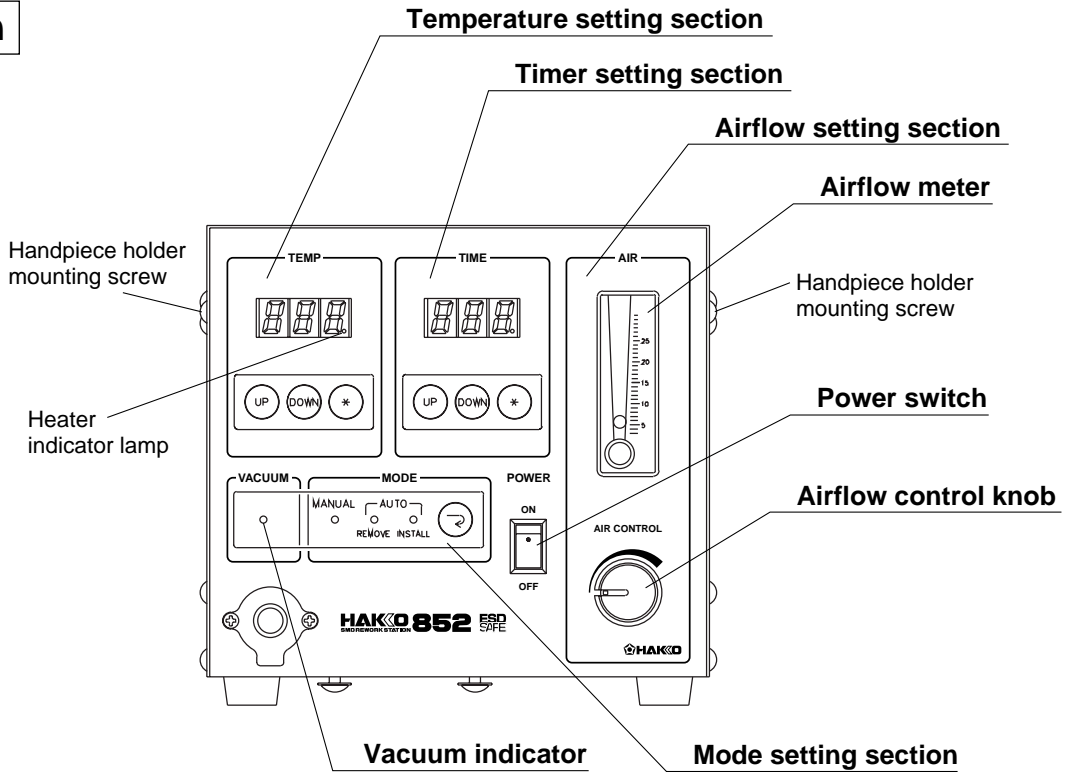

Jack for optional foot-switch

### CAUTION

This jack is for the foot-switch only. Do not connect any other device.

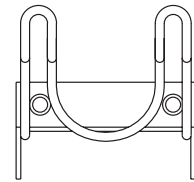
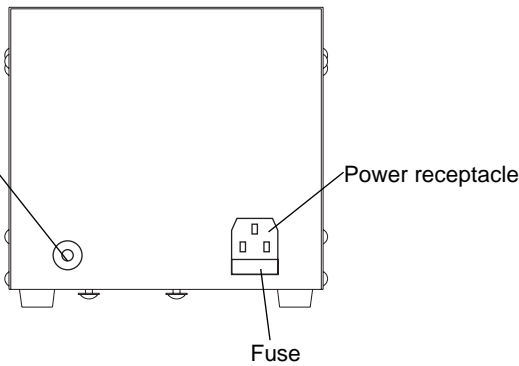

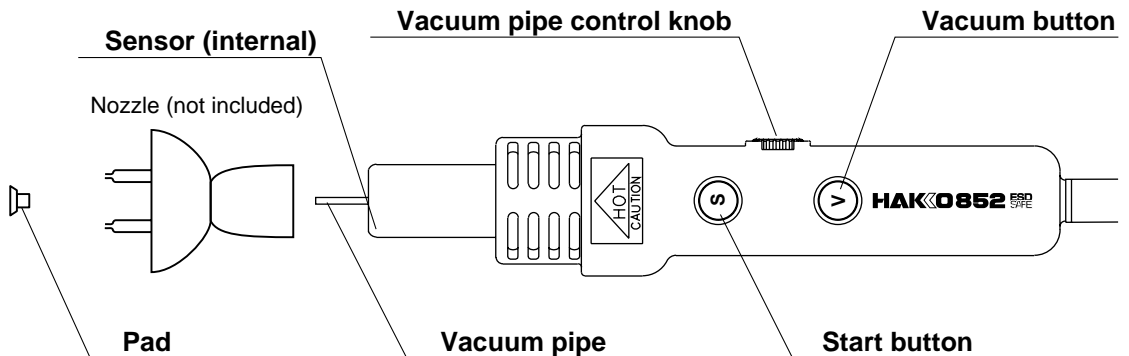

Handpiece holder

## Handpiece



## Station

**Temperature setting section** ..... Use this section for displaying and setting the temperature. The temperature range is 100° to 450°C. (212° to 842°F). The temperature is factory-set to 300°C. (572°F).

  ..... Use these buttons to increase and decrease the temperature.

 ..... When this button is pressed for more than one second, the station enters temperature setting mode. This button is also used to finalize the temperature setting when setting the temperature. When this button is pressed for less than one second, the current temperature setting is displayed.

**CAUTION** Both the temperature displayed and the temperature setting refer to the temperature at the sensor.

**Timer setting section** ..... Use this section for displaying and setting the heating time in Auto mode. The air blow time range is 15 – 999 seconds.

  ..... Use these buttons to increase and decrease the blow time.

 ..... When this button is pressed for more than one second, the station enters timer setting mode. This button is also used to finalize the timer setting when setting the timer. When this button is pressed for less than one second, the current timer setting is displayed.

**Airflow setting section** ..... The airflow can be set within the range of 7 to 20 1/min. Set the airflow using the airflow control knob.

**Airflow meter** ..... This meter indicates the airflow rate. (7 1/min and above)

**Power switch** ..... This switch turns the power ON and OFF.

**Airflow control knob** ..... This knob controls the airflow.

**Mode setting section** ..... Use this section for displaying and selecting the mode. The following three modes can be selected: MANUAL, REMOVE, and INSTALL. Select the mode using  the mode selection button.

**Vacuum indicator** ..... This indicator lights when the vacuum pump is in operation.

## Handpiece

**Pads** ..... The pads hold parts by suction applied through the vacuum pipe.

**Vacuum pipe** ..... The pads are mounted on the tip of the vacuum pipe.

**Sensor (internal)** ..... The sensor detects the temperature of the hot air.

**Start button** ..... ●Manual Mode  
When the Start button is pressed, the unit begins blowing hot air. When the start button is pressed again, the unit begins cooling and stops blowing hot air after reaching 200°C. (392°F)  
●Auto Mode  
When the Start button is pressed, the program begins. When the start button is pressed again, the unit begins cooling.

**Vacuum pipe control knob** ..... This knob controls the length of the vacuum pipe.

**Vacuum button** ..... This button turns the vacuum pump ON and OFF.

# PREPARATION: ASSEMBLY AND ELECTRICAL CONNECTION

## Preparation: Assembly and Electrical Connection

### A. Station Assembly

#### ● Attach the handpiece holder.

Remove the handpiece holder mounting screw from the side of the station. Attach the handpiece holder to the station. (Figure 1) (The handpiece holder can be installed on either the left or right side.)

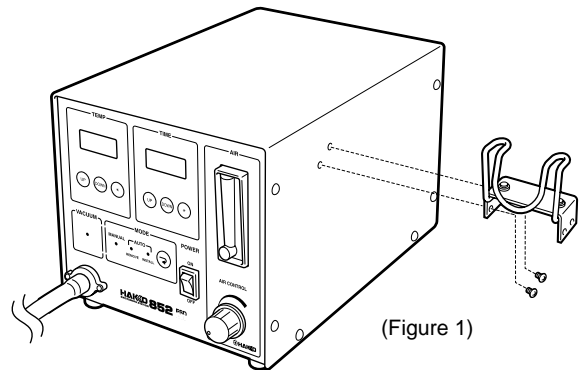

(Figure 1)

### B. Handpiece Assembly

#### ● Using vacuum function operative nozzle (see page 17.)

##### 1. Attach the nozzle.

- Extend the vacuum pipe using the vacuum pipe control knob. (Figure 2)
- Remove the inside screw (M3 x 5) of the nozzle. (Figure 3)
- Loosen the nozzle mounting screw. Pass the vacuum pipe through the nozzle hole and attach the nozzle. (Figure 4)
- Tighten the nozzle mounting screw.

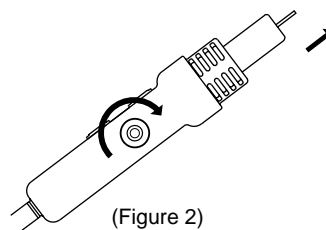

(Figure 2)

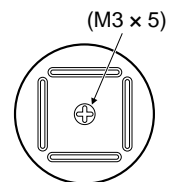

(Figure 3)

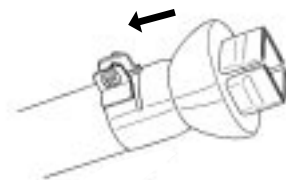

(Figure 4)

##### 2. Attach the pad.

- Attach the pad. (Figure 6)
- Adjust the pad to an appropriate position. Adjust the vacuum pipe so that the pipe and pad protrude as little as possible.

#### ⚠ CAUTION

##### ● Vacuum Pipe

Do not use excessive force.

When not using a nozzle, retract the vacuum pipe to the shortest length. (Figure 5)

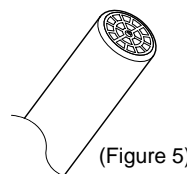

(Figure 5)

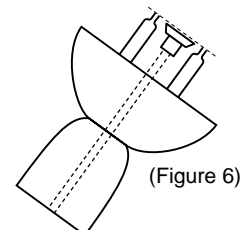

(Figure 6)

#### ⚠ CAUTION

The nozzle and pads reach high temperatures, get very hot. Be sure they are cool before attempting to replace them.

#### ⚠ CAUTION

##### ● Pad

The pads do not last indefinitely. When they become deteriorated, replace them. Since exposure to high temperatures causes them to deteriorate faster, Hakko recommends they be cooled after use.

## ●Using vacuum function inoperative nozzle (see page 18.)

### Attach the nozzle.

- Retract the vacuum pipe to the shortest length using the vacuum pipe control knob. (Figure 5)
- Loosen the nozzle mounting screw. Attach the nozzle. (Figure 4)
- Tighten the nozzle mounting screw.

### **⚠CAUTION**

The pad cannot be used with this type of nozzle.

## C. Electrical Connection and Power ON

- Connect the power cord to the power receptacle on the back panel of the station. (Figure 7)
- Place the handpiece on the holder. (Figure 8)
- Plug the power cord into a grounded wall socket.
- Turn the power switch ON.

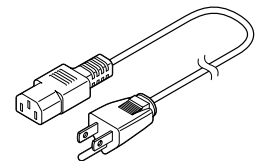
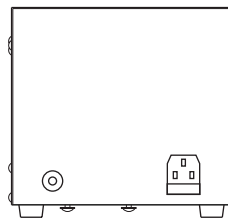

(Figure 7)

### **⚠CAUTION**

This product is ESD-protected. Be sure to use a grounded wall socket.

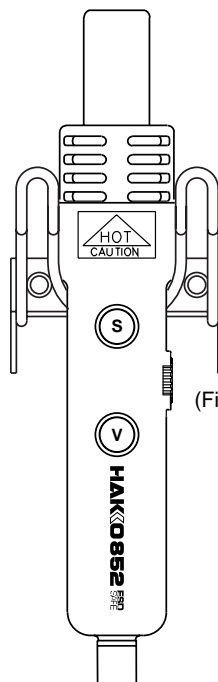

### **⚠CAUTION**

When not in use, place the handpiece on the holder.

(Figure 8 ) Top View

# PREPARATION: ASSEMBLY AND ELECTRICAL CONNECTION

## D. Mode Selection

Select the desired mode using the mode selection button.

The Hakko 852 provides the following three modes:

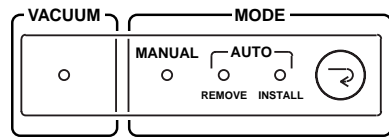

(Figure 9)

- **Manual Mode** (See page 8.)

In this mode, air-blow start and vacuum pump operation are handled entirely by manual operation. Use this mode when setting up Auto mode conditions, performing operations for which no conditions have been established, performing maintenance, or executing a single operation.

- **Remove Mode (AUTO)** (See page 9.)

This mode is used when removing parts. After starting, the heating time can be set by setting the timer. The vacuum pump turns ON automatically.

- **Install Mode (AUTO)** (See page 10.)

This mode is used when installing parts. After starting, the heating time can be set by setting the timer. The vacuum pump turns OFF automatically.



# OPERATION

## Operation in Manual Mode

### ●Selecting Manual Mode

Press the mode selection button and set the mode to MANUAL.

The timer does not operate.  appears on the timer display.

### ●Air Blow

#### 1. Start

Press the Start button on the handpiece (or the foot-switch) to start the flow of air. The hot air blows from the tip of the nozzle, and the temperature is controlled according to the temperature setting.

#### 2. Stop

Press the Start switch again. Power to the heater is shut off and cooling begins. When the temperature falls to 200°C. (392°F.), the air stops blowing and the temperature display reads .

### ●Vacuum Function

This function is used to hold the component securely to the pads.

#### 1. Start

Press the Vacuum button on the handpiece. The vacuum pump turns ON and the part is held by suction.

#### 2. Stop

Press and hold the Vacuum button for **more than 0.3 second**. The vacuum pump turns OFF.

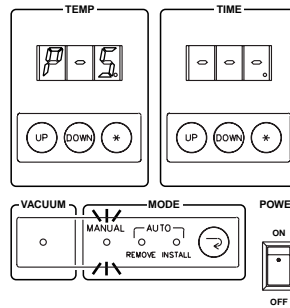

### When checking the temperature setting

Press the  button for less than one second. To change the temperature setting, see "Setting/Changing the Temperature" on page 11.

### ⚠CAUTION

Do not stop the hot air or the vacuum by turning the power switch OFF.

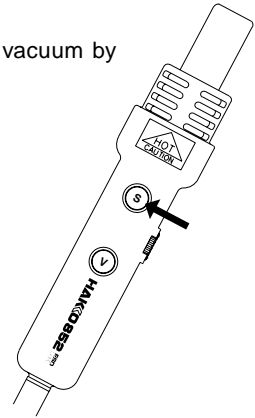

### ⚠CAUTION

To avoid damage to the equipment, do not turn the power switch OFF until  appears on the display.

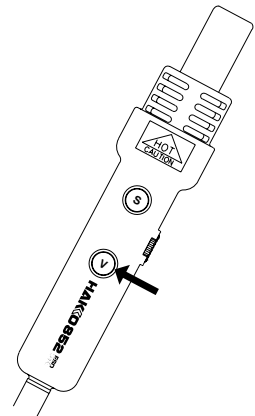

### ⚠CAUTION

Parts held by the pads are very hot. Be careful when removing them from the pads.

# OPERATION

## Auto/Remove Mode

### ●Selecting Remove Mode

Press the mode selection button and set the mode to REMOVE. This mode has the following sequence:

- Start/hot air blow (manual)
- Vacuum ON five seconds before the timer runs out (automatic)
- Vacuum OFF (manual)
- Cooling start and air blow stop (automatic)

### ●Removal

#### ●Preparation

Position the nozzle and pads over the part you wish to remove.

#### Start (heating)

Press the start button on the handpiece (or the foot-switch). Hot air blows from the nozzle and melts the solder. The timer begins counting down. (Figure 1)

#### ⚠CAUTION

To stop the program, press the start button. Cooling begins.

#### Suction

When five seconds remain on the timer, the vacuum automatically turns ON and the part is held by suction. Lift the handpiece and remove the part from the P.W.B.. (Figure 2)

#### Releasing the Part

Release the part by pressing the vacuum button for more than 0.3 second. (Figure 3)

#### Stop

When the timer reaches 0, cooling begins and the air stops blowing as soon as the temperature reaches 200°C. (392°F).

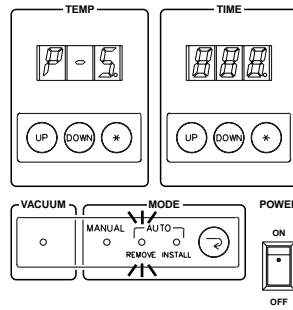

To check the temperature setting, press the \* button for less than one second. To change the temperature setting, see "Setting/Changing the Temperature" on page 11.

To change the air blow time, see "Setting/Changing the Time" on page 12.

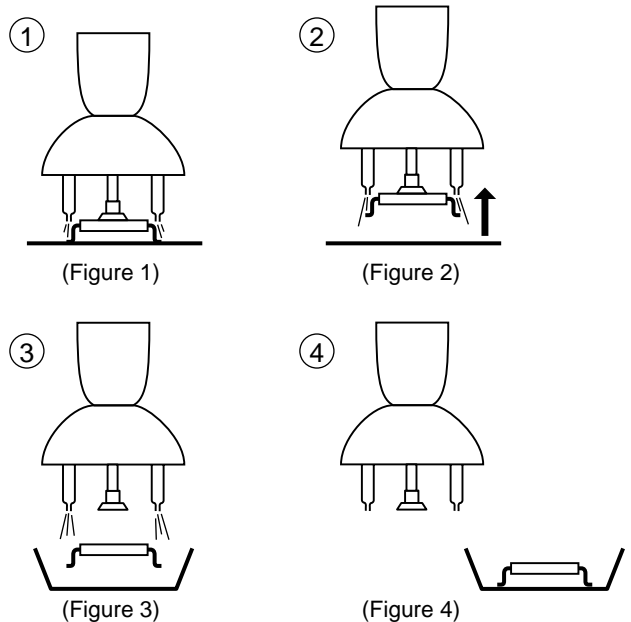

#### ⚠CAUTION

If the vacuum button is pressed before the timer runs down to five seconds, the vacuum pump turns ON and the remaining time is automatically set to five seconds.

#### ⚠CAUTION

The solder that remains on the substrate will be deteriorated. Remove it with a solder remover or some solder wick.

## Auto/Install Mode

### ●Selecting Install Mode

Press the mode selection button and set the mode to INSTALL. This mode has the following sequence:

- Vacuum ON (manual)
- Start/hot air blow (manual)
- Vacuum OFF after five seconds (automatic)
- Cooling start and air blow stop (automatic)

### ●Installation

#### ●Preparation

Apply an appropriate amount of solder paste to P.W.B..

#### Part Suction and Positioning

Press the VACUUM button on the handpiece (or the foot-switch). The part is held to the pads by suction. Position the part over the P.W.B.. (Figure 1)

#### Start

Press the START button. Hot air blows from the nozzle and soldering begins. (Figure 2)

#### Vacuum Stop

After five seconds, the vacuum turns OFF and the part is released from suction. (Figure 3)

#### Stop

When the timer reaches 0, cooling begins. Make sure the solder has hardened before lifting the handpiece. (Figure 4)

#### ⚠CAUTION

While there are many advantages to using hot air for soldering and desoldering, it is possible for the process to result in defects such as bridges or solder balls. Hakko recommends that all operators be made familiar with the equipment. Be sure to inspect each completed product.

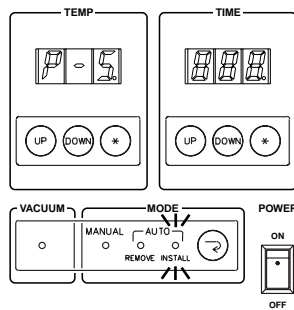

To check the temperature setting, press the \* button for less than one second. To change the temperature setting, see "Setting/Changing the Temperature" on page 11.

To change the air blow time, see "Setting/Changing the Time" on page 12.

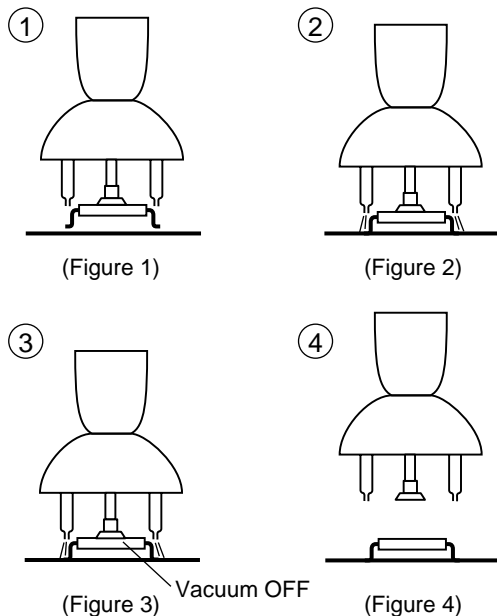

# OPERATION

## Setting/Changing the Temperature

### ⚠CAUTION

The temperature setting range is 100° – 450°C. (212° – 842°F).

- Attempt to enter a value outside the setting range will cause the display to begin flashing the HUNDREDS digit again. Reenter a correct value.
- Both the display temperature and the temperature setting are the temperature at the sensor. (Even with the same temperature setting, the temperature of the hot air differs depending on the nozzle size.)

**Example: Change the temperature setting from 300° to 450°C.**

**1. Press the \*** on temperature setting section for more than one second.

- The station goes into temperature setting mode and the HUNDREDS digit flashes on the display, indicating that the HUNDREDS digit can be entered.

**2. Enter the HUNDREDS digit.**

- Use the **UP** and **DOWN** buttons to select the desired value for the HUNDREDS digit. **Only 1, 2, 3, or 4 can be selected. (In °F mode, 2, 3, 4, 5, 6, 7, and 8 can be selected).** When the desired value is displayed, press the \* button. The TENS digit begins to flash.

**3. Enter TENS digit.**

- Use the **UP** and **DOWN** buttons to select the desired value for the TENS digit. **Any value from 0 to 9 can be selected.** When the desired value is displayed, press the \* button. The UNITS digit begins to flash.

**4. Enter the UNITS digit.**

- Select the desired value for the UNITS digit in the same manner as for the TENS digit.
- Press the \* button.
- The temperature setting is stored in memory. Heater control begins after the new temperature setting is displayed.

### ⚠CAUTION

If the power is turned OFF before the temperature setting procedure is completed, the new setting value will not be stored in memory.

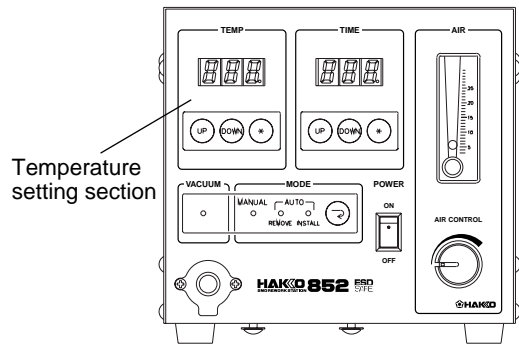

Temperature setting section

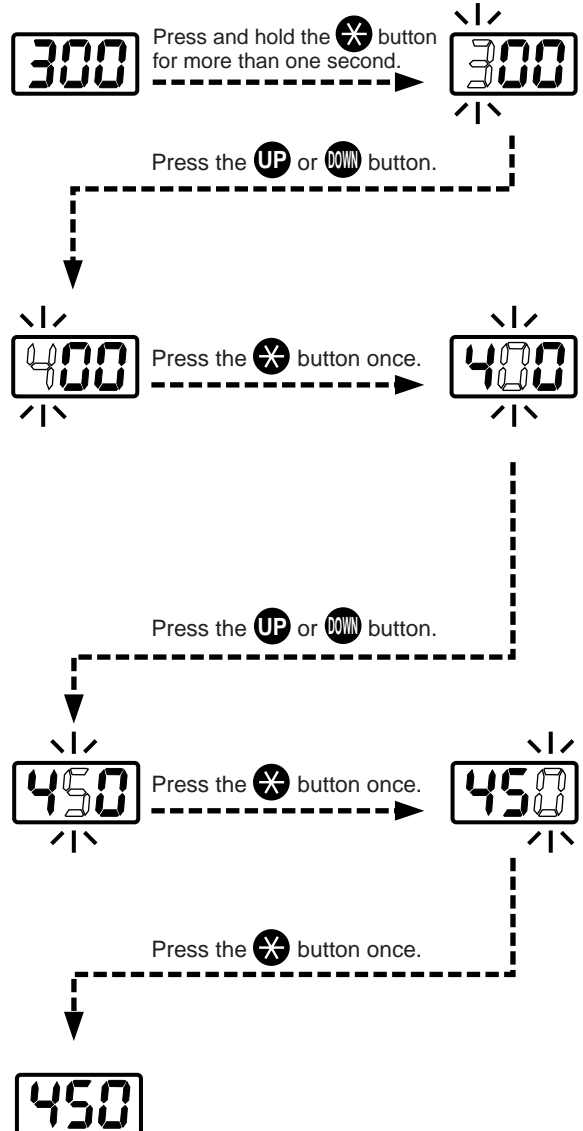

## Setting/Changing the Time

### ⚠ CAUTION

The timer setting range is 15 – 999 seconds.

- Attempt to enter a value outside the setting range will cause the display to begin flashing the HUNDREDS digit again. Reenter a correct value.

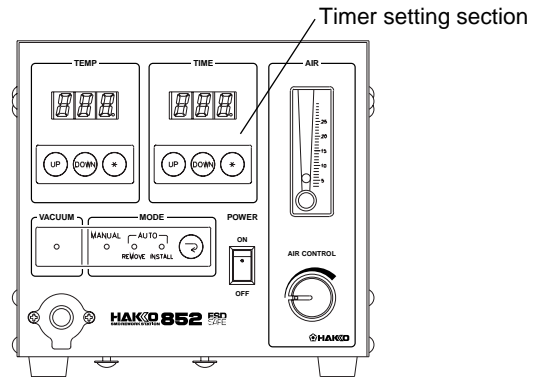



**Example: Change the timer setting from 30 seconds to 100 seconds.**

1. Press the mode selection button  and set the mode to REMOVE or INSTALL.



2. Press the  button on timer setting section for more than one second.

- The station goes into timer setting mode and the HUNDREDS digit flashes on the display, indicating that the HUNDREDS digit can be entered.

3. Enter the HUNDREDS digit.

- Use the  and  buttons to display the desired value for the HUNDREDS digit.
- Press the  button. The TENS digit begins to flash.

4. Enter the TENS digit.

- Use the  and  buttons to display the desired value for the TENS digit.
- Press the  button. The UNITS digit begins to flash.

5. Enter the UNITS digit.

- Select the desired value for the UNITS digit in the same manner as for the TENS digit.
- Press the  button. The timer setting is stored in memory. Heater control begins after the new timer setting is displayed.

### ⚠ CAUTION

If the power is turned OFF before the timer setting procedure is completed, the new setting value will not be stored in memory.

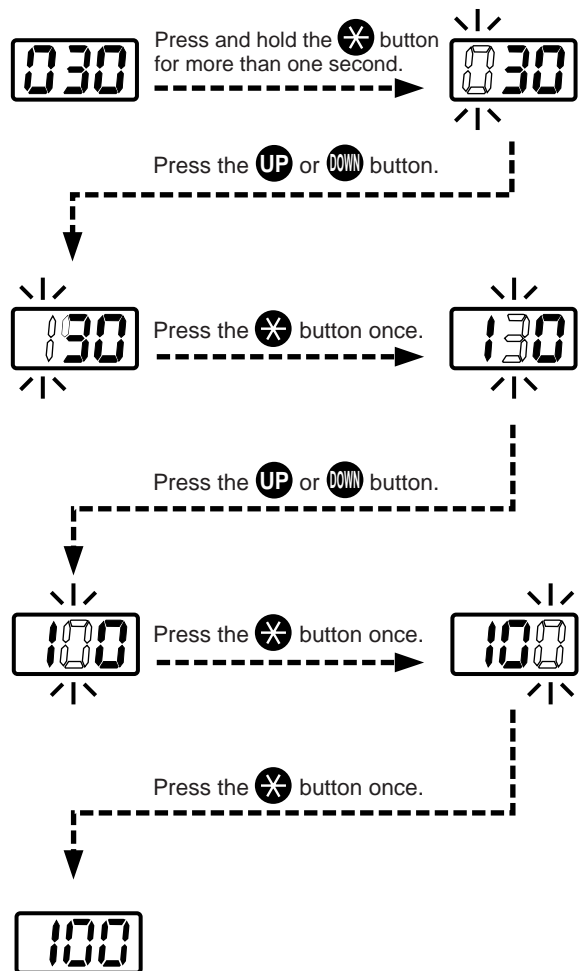

# OPERATION

## Airflow Adjustment

Adjust the flow rate of the hot air while watching the airflow meter. The adjustment range is 7 1/min to 20 1/min.

### CAUTION

Do not apply excessive force when turning the airflow control knob.

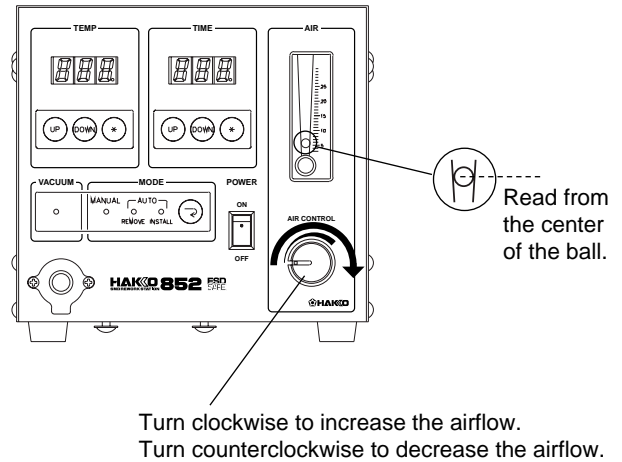

# PARAMETERS / INITIAL RESETTING

## ● Entering the Parameters

### °C (Celsius) or °F (Fahrenheit) Temperature Display

### Power Save Time

The power save function automatically turns off the hot air when it has blown continuously for a specified amount of time in manual mode. Power to the heater is turned off and then the air is stopped after the handpiece cools.

### Sensor Temperature Display

#### ⚠ CAUTION

If the power is turned OFF before the parameter setting procedure is completed, the new setting values will not be stored in memory.

## ● Initial Reset

Turn the power switch ON while simultaneously pressing the **UP**, **DOWN**, and **✖** buttons on the temperature setting section. The station will be reset to the following initial values:

The Hakko 852 has the following three parameters:

- 1) °C or °F temperature display selection
- 2) Power save time (select 30 or 60 minutes)
- 3) Sensor temperature display

Once the station enters parameter mode, set the parameters in the order shown below. After all the parameters have been set, normal operation will be resumed.

1. Turn the power switch OFF .
2. Press and hold down the **UP** and **DOWN** buttons on the temperature setting section simultaneously and then turn the power switch ON.
3. Continue holding down both buttons until the display shows  (for Celsius) or  (for Fahrenheit). When the display shows  or , the station is in parameter input mode.

● Pressing the **UP** or **DOWN** button will cause  or  to be displayed alternately.

● Press the **✖** button to select the scale. The power save time may now be entered.

● When the station enters power save time setting mode, either  or  is displayed. Either 30 minutes or 60 minutes can be selected.

● Pressing the **UP** or **DOWN** button will cause  or  to be displayed alternately.

● Press the **✖** button to enter your selection. The sensor temperature may now be displayed.

● No data entry is required.

The value displayed is the temperature currently detected by the sensor.

● To end parameter input mode, press the **✖** button. After displaying the temperature setting for two seconds, the station returns to normal mode.

°C/°F selection	°C
Power save time	30 minutes
Temperature setting	300°C
Timer setting 30 seconds	30 seconds
Mode	Manual

# MAINTENANCE / INSPECTION

## ●Broken Heater or Sensor

### Open the handpiece.

1. Retract the vacuum pipe to its shortest length.
2. Remove the three screws holding the handpiece together.
3. Move the tube downward.
4. Remove the pipe from the protruding portion of the handle.

#### ⚠CAUTION

Quartz glass and heat insulation are inside the pipe. Be careful not to drop or lose these items.

5. Disconnect the heater sensor connector and remove the heater.

#### ⚠CAUTION

Do not apply excessive force to the vacuum pipe.

### Measure the resistance value.

1. Measure the resistance value (a) of the sensor. The correct value is  $0 \Omega$ .
2. Measure the resistance value (b) of the heater. The correct values are approximately  $33 \Omega (\pm 10\%)$  (100-120 V),  $85 \Omega (\pm 10\%)$  (220-240 V) at room temperature. If the resistance value is incorrect, replace the part.

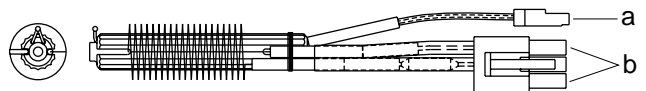
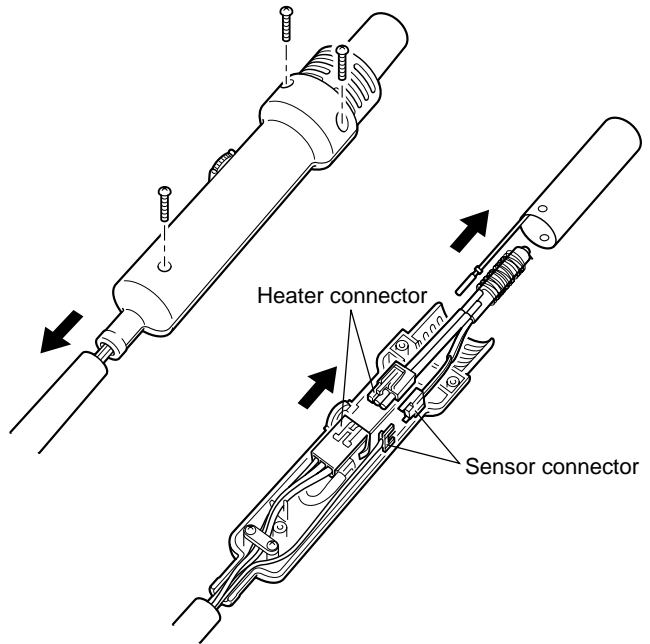

## ●Replacing the Fuse

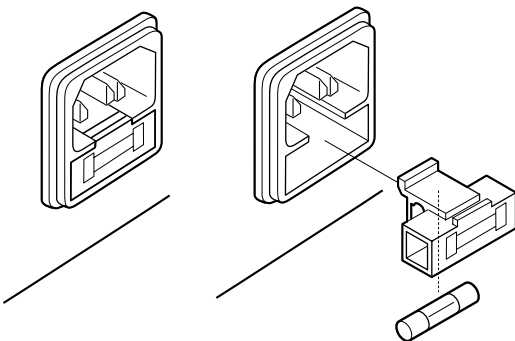

1. Unplug the power cord from the power receptacle.
2. Remove the fuse holder.
3. Replace the fuse.
4. Put the fuse holder back in place.



# ERROR MESSAGES

When the error detection software in the Hakko 852 detects an error, a message is displayed to alert the operator. See "Troubleshooting" for procedures to correct the error.



This error occurs when there is the possibility of a sensor failure (or a failure in the sensor circuit). **S-E** flashes and the power is shut down.

This error occurs when the temperature of the hot air is falling even though the heater is on. The **H-E** flashes to indicate the possibility of a heater failure.

## TROUBLESHOOTING

### WARNING

● Before checking the inside of the Hakko 852 or replacing parts, be sure to disconnect the power plug. Failure to do so may result in electric shock.

- The unit does not operate when the power switch is turned ON.
- **S-E** flashes, indicating a sensor error.
- **H-E** flashes, indicating a heater error.
- The timer cannot be set.
- The vacuum pump does not stop when the vacuum button is pressed.

**CHECK** : Is the power cord disconnected?

**ACTION** : Connect it.

**CHECK** : Is the fuse blown?

**ACTION** : Investigate why the fuse blew and then replace the fuse. If the cause can not be determined, replace the fuse. If the fuse blows again, send the unit in for repair.

**CHECK** : Is the sensor broken?

**ACTION** : See the procedure for checking a potentially broken sensor (p.15).

**CHECK** : Is the heater broken?

**ACTION** : See the procedure for checking a potentially broken heater (p.15).

**CHECK** : Is the station in Auto mode?

**ACTION** : Put the station into Auto mode.

**CHECK** : Is the value outside the setting range?

**ACTION** : Enter a value that is within the setting range.

**CHECK** : Is the vacuum button being pressed for less than 0.3 second?

**ACTION** : Press the vacuum button for more than 0.3 second.

# OPTIONAL PARTS

mm (inch)

## ● Nozzles

### NOTE

The size in Name/Specification indicates the size of IC package.

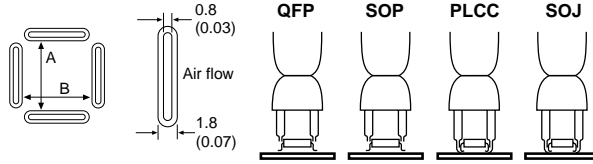

## ● VACUUM FUNCTION OPERATIVE NOZZLES.

**A1125B** QFP 10 × 10  
(0.39 × 0.39)

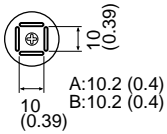

**A1126B** QFP 14 × 14  
(0.55 × 0.55)

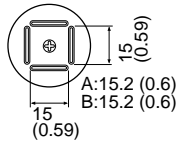

**A1127B** QFP 17.5 × 17.5  
(0.68 × 0.68)

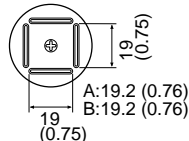

**A1128B** QFP 14 × 20  
(0.55 × 0.78)

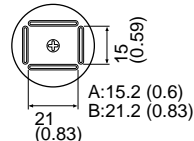

**A1129B** QFP 28 × 28  
(1.1 × 1.1)

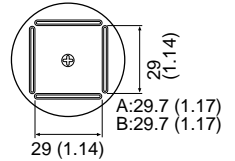

**A1135B** PLCC 17.5 × 17.5  
(0.68 × 0.68)  
(44 Pins)

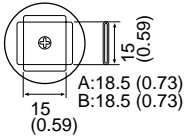

**A1136B** PLCC 20 × 20  
(0.78 × 0.78)  
(52 Pins)

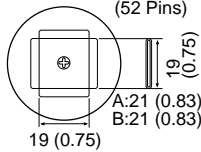

**A1137B** PLCC 25 × 25  
(0.98 × 0.98)  
(68 Pins)

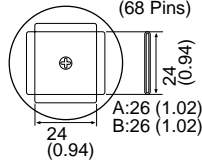

**A1138B** PLCC 30 × 30  
(1.18 × 1.18)  
(84 Pins)

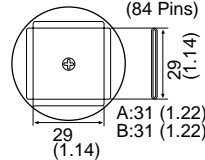

**A1139B** PLCC 12.5 × 7.3  
(0.49 × 0.29)  
(18 Pins)

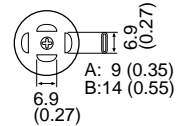

**A1140B** PLCC 11.5 × 11.5  
(0.45 × 0.45)  
(28 Pins)

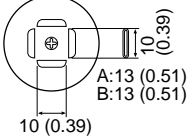

**A1141B** PLCC 11.5 × 14  
(0.45 × 0.55)  
(32 Pins)

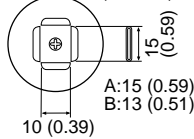

**A1182B** BQFP 24 × 24  
(0.94 × 0.94)

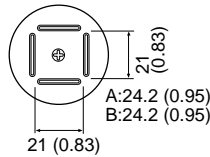

**A1187B** TSOL 18.5 × 8  
(0.73 × 0.31)

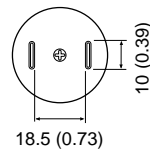

**A1257B** SOP 11 × 21  
(0.43 × 0.83)

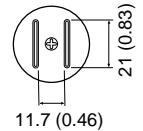

**A1258B** SOP 7.6 × 12.7  
(0.3 × 0.5)

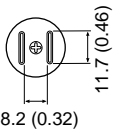

**A1259B** SOP 13 × 28  
(0.51 × 1.1)

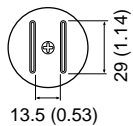

**A1260B** SOP 8.6 × 18  
(0.34 × 0.71)

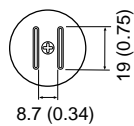

**A1261B** QFP 20 × 20  
(0.78 × 0.78)

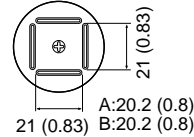

**A1262B** QFP 12 × 12  
(0.47 × 0.47)

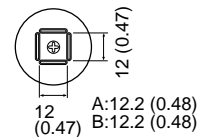

**A1263B** QFP 28 × 40  
(1.1 × 1.57)

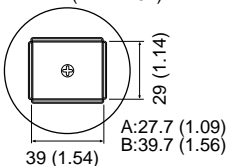

**A1264B** QFP 40 × 40  
(1.57 × 1.57)

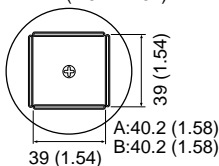

**A1265B** QFP 32 × 32  
(1.26 × 1.26)

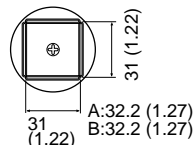

## ●VACUUM FUNCTION INOPERATIVE NOZZLES.

**A1124B** Single 2.5  
(0.09)



**A1130** Single 4.4  
(0.17)



**A1131** SOP 4.4 × 10  
(0.17 × 0.39)

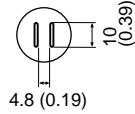

**A1132** SOP 5.6 × 13  
(0.22 × 0.51)

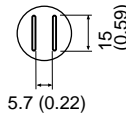

**A1133** SOP 7.5 × 15  
(0.3 × 0.59)

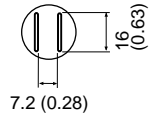

**A1134** SOP 7.5 × 18  
(0.3 × 0.7)

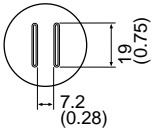

**A1142B** Bent Single 1.5 × 3  
(0.06 × 0.12)

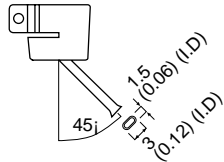

**A1325** Dual Single 1.5 × 5-10  
(0.06 × 0.2-0.39)  
Adjustable Pitch

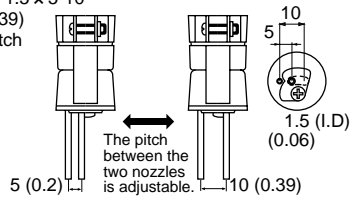

**CAUTION** Be sure **not** to use **No. A1124** Single 2.5 (0.09) and **No. A1142** Bent Single 1.5 × 3 (0.06 × 0.12) nozzle with the Hakko 852. These nozzles do not have space to blow hot air, using them with the 852 may result in danger.

## ●FOOT-SWITCH

The foot-switch can be used to perform the same operation as the start button and the vacuum button on the handpiece.

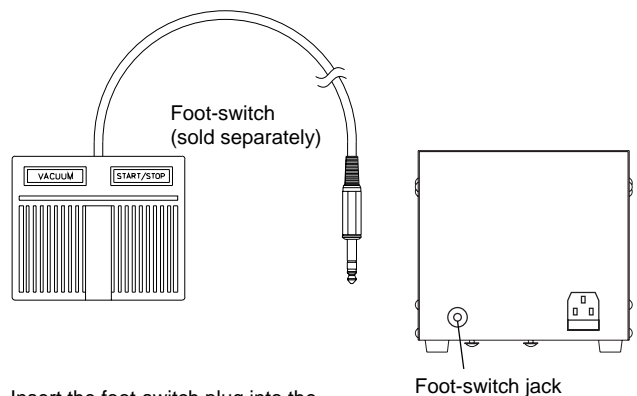

Insert the foot-switch plug into the foot-switch jack on the back of the station.

# PARTS LIST / STATION

\*Spare or repair parts do not include mounting screws, if they are not listed on the description. Screws must be ordered separately.

Item No.	Part No.	Part Name	Description
1	B2461	P.W.B./display	
2	B2462	P.W.B./heat control	100-120 V With triac
	B2482	P.W.B./heat control	220-240 V With triac
3	B2463	Radiation sheet	
4	B2317	Insulation sheet	
5	B1084	Switch	
6	B1028	Knob	With screw
7	B2464	Cover	
8	B2465	Chassis	With display window, membrane sheet
9	B2466	Jack for footswitch	

Item No.	Part No.	Part Name	Description
10	B2467	Transformer	100 V
	B2483	Transformer	110 V
	B2479	Transformer	120 V
	B2484	Transformer	220-230 V
	B2485	Transformer	240 V
11	B2384	Power receptacle	
12	B2468	Fuse 125V-5A	100-120 V
	B1258	Fuse 250V-3.15A	220-240 V
13	B2419	Power cord, 3 core & American plug	
	B2421	Power cord, 3 core, no plug	
	B2422	Power cord, 3 core, BS plug	India
	B2423	Power cord, 3 core, European plug	Korea
	B2424	Power cord, 3 core, European plug	Eur.
	B2425	Power cord, 3 core, BS plug	U.K.
	B2426	Power cord, 3 core, Australian plug	
14	B2469	Vacuum pump	

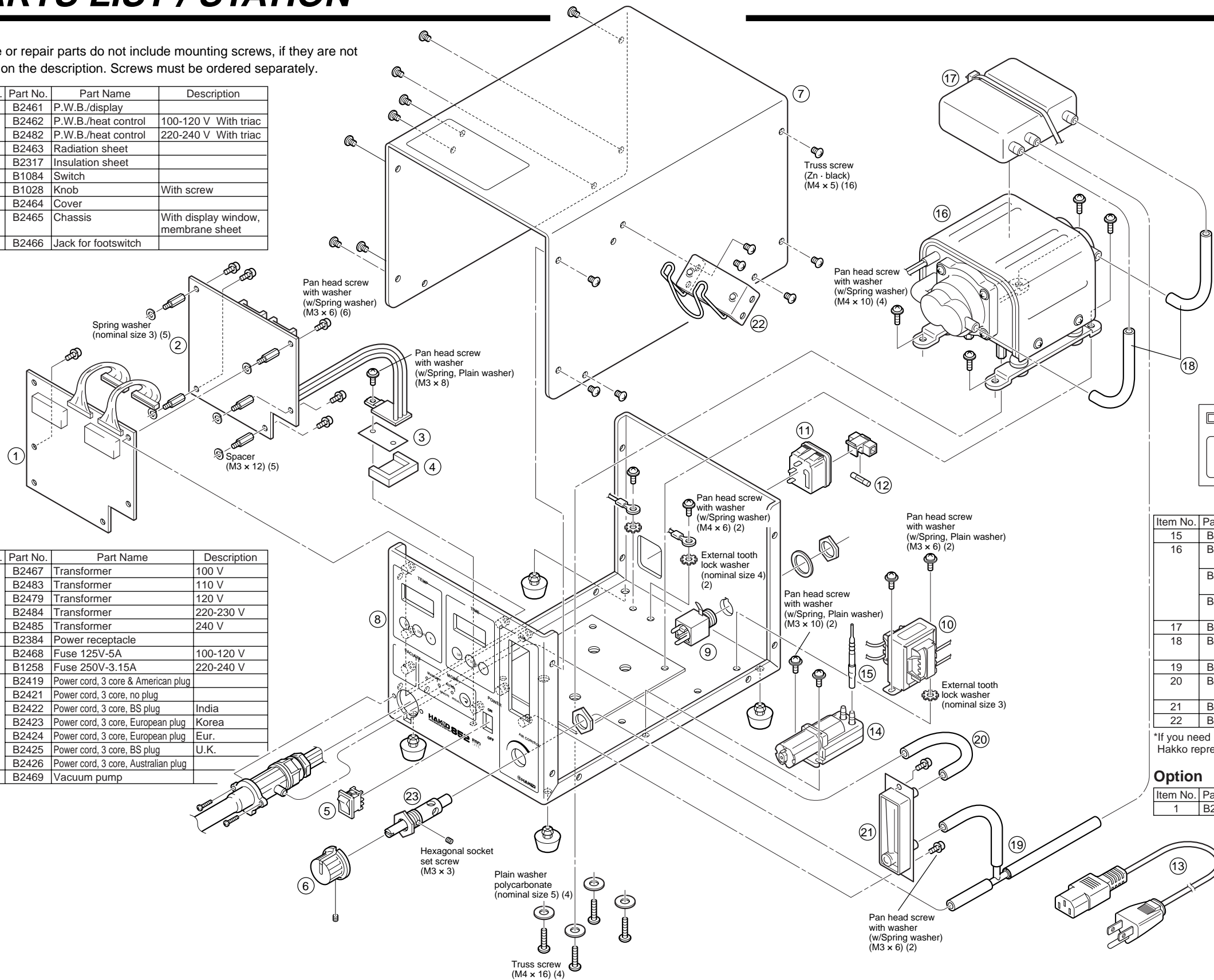

## Option

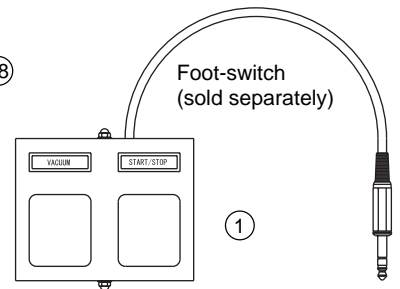

Item No.	Part No.	Part Name	Description
15	B2470	Tube joint	With silicone tube
16	B2471	Air pump	100 V, With high nut, nylon band, double-side tape
	B2480	Air pump	110-120 V, With high nut, nylon band, double-side tape
	B2481	Air pump	220-240 V, With high nut, nylon band, double-side tape
17	B2472	Sound-proof tank	
18	B2473	Silicone tube	8 x 5 x 130 / mm 0.3 x 0.2 x 5.1 / in.
19	B2474	Tube connector	With silicone tube
20	B2475	Silicone tube	8 x 5 x 205 / mm 0.3 x 0.2 x 8.1 / in.
21	B2476	Air flow meter	
22	B2477	Handpiece holder	assembly

\*If you need item no. 23. Exhaust nozzle, contact your Hakko representative.

## Option

Item No.	Part No.	Part Name	Description
1	B2478B	Foot-switch	

# PARTS LIST / HANDPIECE

\*Spare or repair parts do not include mounting screws, if they are not listed on the description. Screws must be ordered separately.

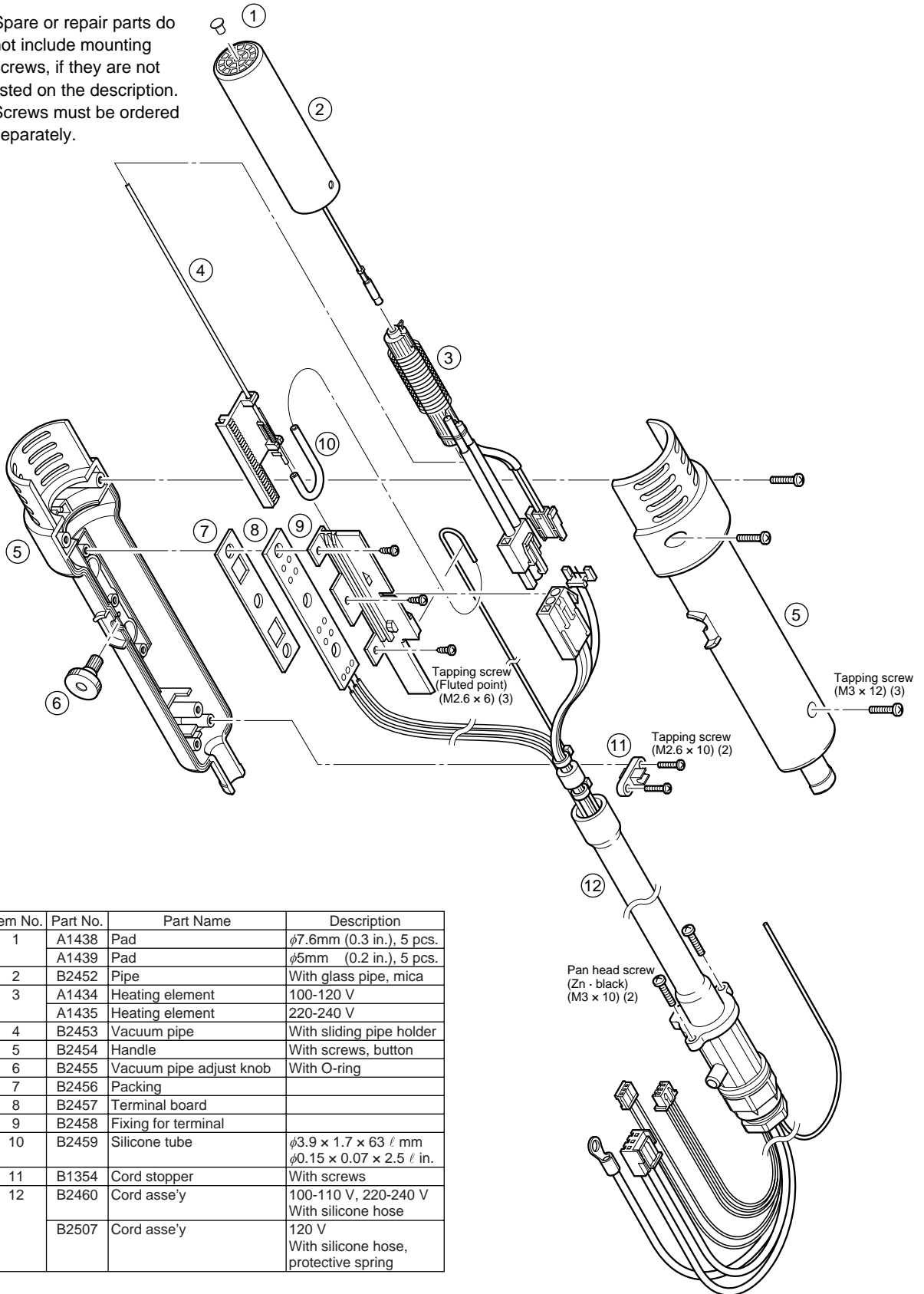

Item No.	Part No.	Part Name	Description
1	A1438	Pad	$\phi 7.6\text{mm}$ (0.3 in.), 5 pcs.
	A1439	Pad	$\phi 5\text{mm}$ (0.2 in.), 5 pcs.
2	B2452	Pipe	With glass pipe, mica
3	A1434	Heating element	100-120 V
	A1435	Heating element	220-240 V
4	B2453	Vacuum pipe	With sliding pipe holder
5	B2454	Handle	With screws, button
6	B2455	Vacuum pipe adjust knob	With O-ring
7	B2456	Packing	
8	B2457	Terminal board	
9	B2458	Fixing for terminal	
10	B2459	Silicone tube	$\phi 3.9 \times 1.7 \times 63 \ell$ mm $\phi 0.15 \times 0.07 \times 2.5 \ell$ in.
11	B1354	Cord stopper	With screws
12	B2460	Cord asse'y	100-110 V, 220-240 V With silicone hose
	B2507	Cord asse'y	120 V With silicone hose, protective spring

# WIRING DIAGRAM

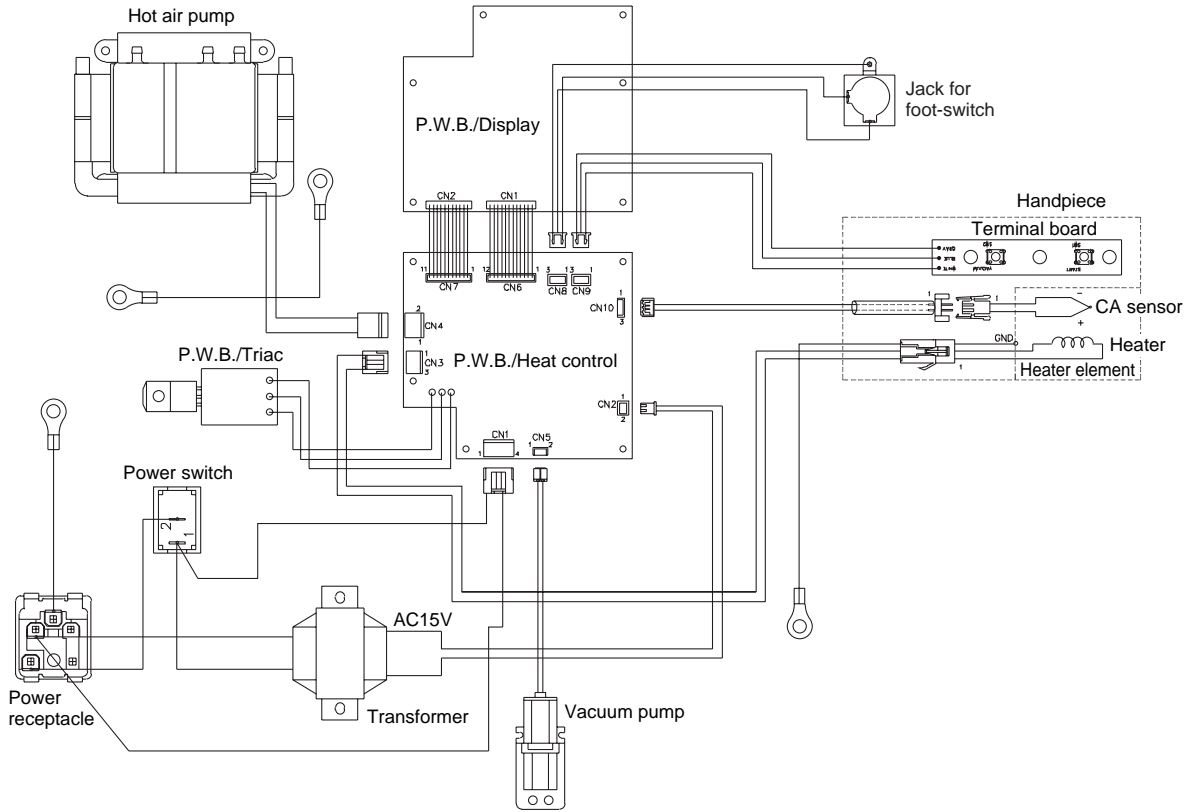



#### OVERSEAS AFFILIATES

**U.S.A.: AMERICAN HAKKO PRODUCTS, INC.**  
25072 ANZA DR. SANTA CLARITA, CA 91355, U.S.A.  
TEL: (661) 294-0090 FAX: (661) 294-0096  
Toll Free (800)88-HAKKO  
4 2 5 5 6

<http://www.hakkousa.com>

**HONG KONG: HAKKO DEVELOPMENT CO., LTD.**  
ROOM 1504, EASTERN HARBOUR CENTRE,  
28 HOI CHAK STREET, QUARRY BAY, HONG KONG.  
TEL: 2811-5588 FAX: 2590-0217  
<http://www.hakko.com.hk/>

**CHINA: HAKKO DEVELOPMENT CO., LTD.**  
ROOM 1112-1115, 11 FLOOR, INTERNATIONAL BANK  
TOWER 191 DONGFENG ROAD WEST, GUANGZHOU  
510180, CHINA.  
TEL: (020)8135-0112, 8135-0113 FAX: (020)8135-0181

#### HEAD OFFICE

4-5, SHIOKUSA 2-CHOME, NANIWA-KU, OSAKA, 556-0024 JAPAN  
TEL: +81-6-6561-3225 FAX: +81-6-6561-8466  
<http://www.hakko.com>

**TAIWAN: HAKKO DEVELOPMENT CO., LTD.**  
3F., NO 110, CHUNG HSIN RD., SEC.3, SANCHUNG, TAIPEI  
HSIEN, TAIWAN.  
TEL: (02)2975-2600 FAX: (02)2973-9565

**S'PORE: HAKKO PRODUCTS PTE., LTD.**  
1, GENTING LINK #02-04, PERFECT INDUSTRIAL  
BUILDING, SINGAPORE 349518  
TEL: 748-2277 FAX: 744-0033  
E-mail: sales@hakko.com.sg

**MALAYSIA: HAKKO PRODUCTS SDN BHD**  
**MALAYSIA HEAD OFFICE**  
NO.22,JALAN PEMBERITA U1/49,SEKSYEN U1,  
TEMASYA INDUSTRIAL PARK,40150 GLENMARIE,  
SHAH ALAM,SELANGOR DARUL EHSAN,WEST MALAYSIA.  
TEL: (03)5569-5223 FAX: (03)5569-5221  
E-mail:hakkokl@tm.net.my

**PENANG BRANCH:** TEL: (04)507-0888 FAX: (04)507-0999  
**JOHOR BAHRU BRANCH:** TEL: (07)236-7766 FAX: (07)237-4655

**PHILIPPINES: HAKKO PHILS TRADING CO., INC.**  
NO. 415 WINDSOR TOWER CONDOMINIUM,  
163 LEGASPI ST., LEGASPI VILLAGE MAKATI,  
METRO MANILA, PHILIPPINES  
TEL: (02)817-0712, 815-4993 FAX: (02)810-7649  
E-mail: hakkophil@pacific.net.ph

**INDONESIA: P.T. HAKKO PRODUCTSTAMA INDONESIA**  
COMP BUMI INDAH BLOK IV NO. 40 NAGOYA BATAM, INDONESIA.  
TEL: (778)457-459 FAX: (778)452-772  
E-mail: hakkobtm@indosat.net.id  
**P.T. HAKKO PRODUCTSTAMA INDONESIA**  
KEBON JERUK PLAZA, BLOK D NO. 6, JALAN RAYA PERJUANGAN,  
JAKARTA BARAT, JAKARTA 11530, INDONESIA.  
TEL: (21)532-4083 FAX: (21)532-4082  
E-mail: hakkojkt@cbr.net.id